

# Power redefined.

**HOMAG**

**Our panel dividing saws**  
SAWTEQ B-500

**YOUR SOLUTION**





## SAWTEQ B-500 – power and performance without compromise

Performance is a question of capability and capacity. For the SAWTEQ B-500 saws we have combined both: The high-performance saws impress thanks to their uncompromising technology and enormous material throughput at maximum availability, ensured by the fact that the saws are exceptionally easy to service and maintain. The result is a combination of well-thought-out designs and leading technology. In short: the SAWTEQ B-500 stands for maximum performance and durability, combined with the greatest possible flexibility when it comes to saw configurations.

### YOUR SOLUTION

### CONTENTS

- 04 Software
- 16 SAWTEQ B-500
- 18 SAWTEQ B-500 with lifting table
- 20 SAWTEQ B-500 as angular saw unit
- 22 Standard features
- 32 Optional features
- 49 Technical data
- 50 Service

## What's different? The software!

It efficiently integrates the machine into the production process. This results in seamless, intelligently networked processes from start to finish. In short: the right software unlocks new value-added potential. That is what makes it so important.





## CADmatic 5 – intuitive to operate and open for digital networking

CADmatic 5 is the state-of-the-art, high-performance saw control system from HOMAG. It provides a vast range of functions and great ease of use thanks to its intuitive operating concept and clear administrative functions. What's more, CADmatic 5 is open for communication with other machines and software solutions.

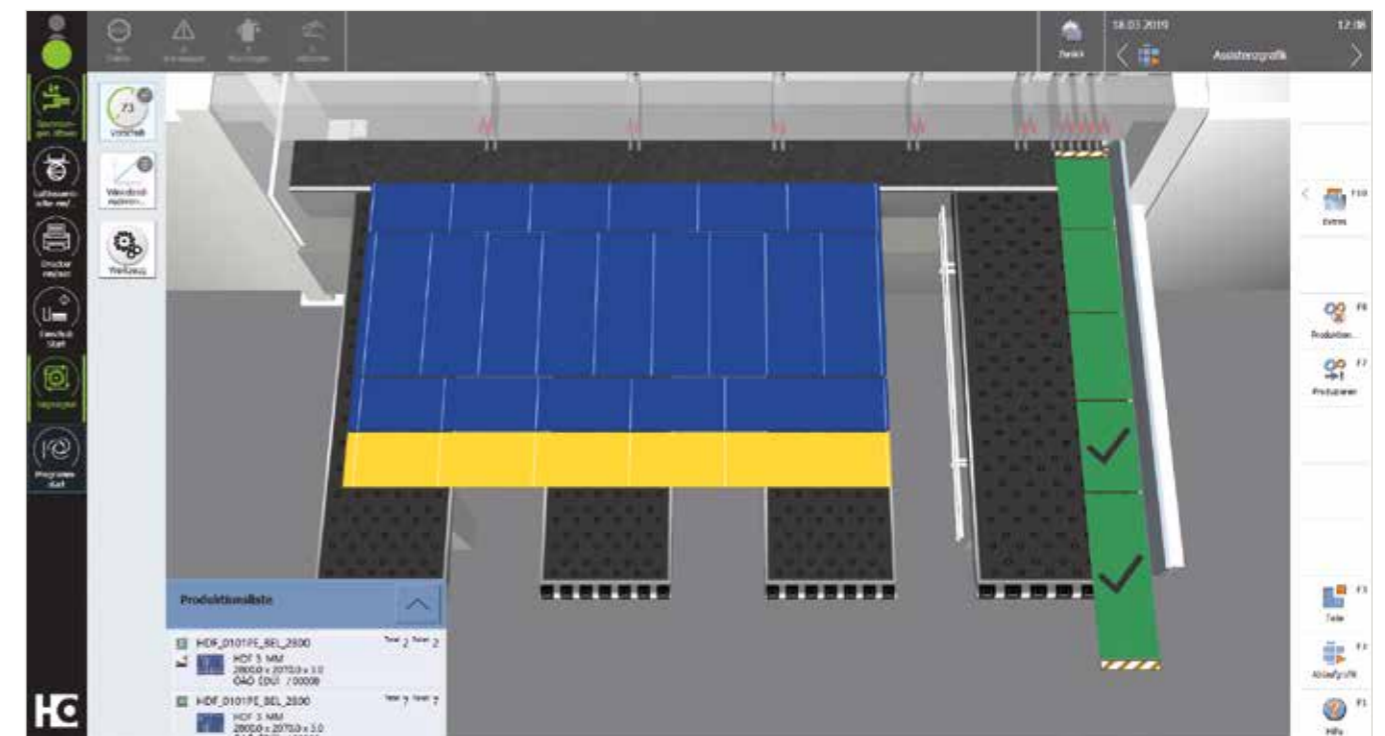

### CADmatic 5 – the change in perspective

The latest generation of the HOMAG saw controller features a new assistance graphic that clearly shows the machine operator what he has to do next. Compared to the previous process graphic that showed all the work steps of the saw (and can still be called up if required), this new graphic represents a 180-degree change in perspective!

#### Highlights:

- The new 3D assistance graphic supports the operator and is intuitive to use, which shortens the training period and reduces errors to a minimum
- This results in efficient processes and a steady output
- Simple handling via tapping and swiping (touch functions)
- Quick change between the individual sections
- Graphically supported diagnostics
- powerTouch user interface
- Ready for connection to tapio
- 21" full-HD widescreen monitor with multi-touch display

**Find out more in the "CADmatic" brochure.**

## The next generation of powerTouch: **powerTouch2**

Faster, more comfortable, clearer: enjoy the benefits of our further improved powerTouch user interface. We have optimized our standardized operating concept and further adapted it to our customers' requirements. Controlling your HOMAG machines is now even faster and more intuitive. The new, modern design has a clear structure. The innovative touch operation allows you to achieve the desired result easily and comfortably.



Our successful powerTouch philosophy – **standardized, simple, ergonomic, evolutionary** – systematically enhanced

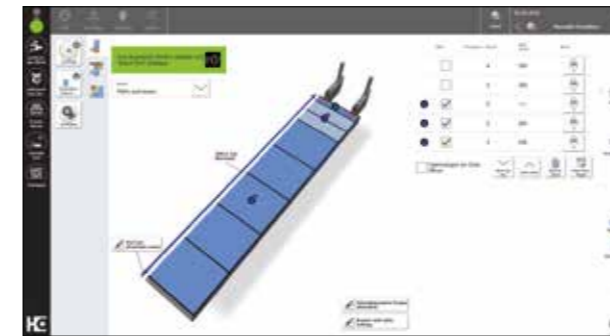

### **Clearer structure**

The layout of the powerTouch2 screen is even clearer. You only see the information that is relevant for you. The important points at a glance – but you still have all the details. All in a fresh, attractive design.



### **Even faster**

With the new powerTouch generation, you can enter information at your machine even more quickly. Compared to the previous version, you can achieve a time saving of up to 30%. This is possible thanks to new features, such as automatic word completion, a pop-up keyboard that can be kept open and Windows-like functions, such as the selection of common actions directly via the start button.



### **More comfortable**

We have also improved the traffic light dialog and the "Start" menu. When you press and hold the program icon, not only are the possible actions displayed, you can also access and activate them directly. Operation is therefore immediate and you do not lose any time opening applications. What's more, for the applications, illustrations and additional information can be displayed instead of simple program icons. This also provides more transparency and avoids unnecessary navigation into applications.



### **More intuitive**

Operating the machine is child's play. Many of the functions are similar to those of a smartphone or tablet and will therefore be familiar to you. Even beginners will feel immediately at ease and will soon be able to control the machine comfortably.

## Optional features: increasing productivity with the appropriate cutting optimization software

Production time, material yield, parts handling and logistical process: efficient panel cutting with seamless processes requires intelligently optimized cutting patterns. For HOMAG saws, you can get the appropriate optimization solution on demand – from large to small, as permanently installed software or directly from the tapio cloud. You have the choice because the SAWTEQ B-500 is now tapio-ready.



### intelliDivide – the easy way to first-class optimization results

Simply upload the parts list. Done! The result? A choice of several alternatives for cutting patterns and entire runs. That's how easy intelliDivide makes it.

In detail: the cloud-based optimization software intelliDivide utilizes significantly higher computing capacities than does locally installed optimization software and can therefore swiftly provide the user with multiple variants of an optimization result.

This means that with intelliDivide, the operator can choose from a variety of options, including a result based purely on reducing waste, a result based on the shortest machine time or on the simplest handling, perfectly adapted to the relevant requirements.

Applications are varied and are geared towards both the trade and industry. Would you, for example, occasionally like to optimize cutting patterns without having to buy, install and maintain a software solution? Then intelliDivide is just what you need. This is because you can use intelliDivide quite simply on an on-demand basis, as software as a service.

However, intelliDivide is also very interesting for large companies. Why is that so? Because, via the cloud, you can optimize your cutting patterns extremely quickly, intelligently and accurately with the help of a powerful calculation engine.

The SAWTEQ B-500 is tapio-ready, allowing intelliDivide to recognize the machine configuration of your saw and take it into consideration for every optimization run in the cloud, completely automatically. This pays off every time in the case of high material throughput.



### Cut Rite cutting optimization software

Efficiency through planning: this short phrase sums up the key benefits of the Cut Rite software. With this world-leading software solution, you can optimize waste and systematically lower the overall costs for cutting.

- Optimized project control
- Efficient cutting processes
- Full control of costs
- Faster calculations

**Find out more in the “Cut Rite” brochure.**

### CADplan

As an alternative to the comprehensive Cut Rite optimization software, CADplan, an add-on module for CADmatic, can also be used to perform small optimization jobs directly at the saw.

# Optional feature: IntelliGuide – innovative smart operator guidance

IntelliGuide is the first assistance system in the history of panel dividing technology to enable saws to respond to the actions of the machine operator in an intelligent and flexible manner. The assistance system becomes more intelligent with each stage of expansion: from IntelliGuide basic, to advanced, right through to professional. So you get exactly your solution.



[MORE AT HOMAG.COM](https://www.homag.com)



IntelliGuide

### General benefits of IntelliGuide

- Intuitive machine operation
- Systematic means of avoiding errors
- Fast processes: operator and saw work in tandem and do not slow each other other down
- The operator rarely needs to look at the monitor and so can concentrate on processing the cutting pattern
- Fluid, ergonomic processes for efficient and concentrated work
- Easy to change operator at any time



### The foundation:

#### 1. CADmatic 5

IntelliGuide is the result of a long period of technical evolution. It all started with the CADmatic saw control system – software that has since become indispensable. The latest version of the software, CADmatic 5, is now more focused on the user than ever before. This is thanks to a new assistance graphic in CADmatic 5 that clearly shows the operator the next step they have to perform. Compared to the previous process graphic that showed all the work steps of the saw (and can still be called up if required), this new graphic represents a 180-degree change in perspective!

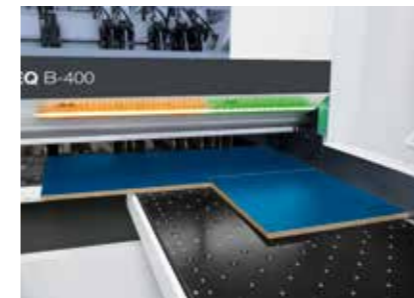

### IntelliGuide basic:

#### 1. CADmatic 5

#### 2. LED strip at the cutting line

- Colored LED signals at the cutting line allow intuitive operation and fast, reliable work
- Using the colored LED elements, machine operators can immediately see if a part has been fully processed, needs to be cut again or can be disposed of as waste
- Based on the LEDs that are lit up, the operator can determine whether the workpiece being processed meets the required specifications

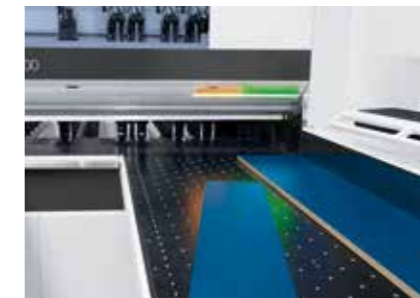

### IntelliGuide advanced:

#### 1. CADmatic 5

#### 2. LED strip at the cutting line

#### 3. Camera

- The system uses this camera to see which strip or part the operator has deposited and how it has been aligned
- If the intended part is not deposited, IntelliGuide responds to the change of plan in a flexible manner
- If no further action is necessary, the saw starts working after brief confirmation. Otherwise, IntelliGuide provides the operator with feedback and instructions

#### 4. Illumination

- Enhances safety and quality by ensuring the workplace and workpieces are evenly lit
- Improves the appearance of the workplace and makes it even more ergonomic

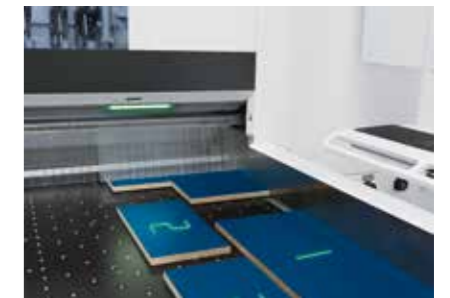

### IntelliGuide professional:

#### 1. CADmatic 5

#### 2. LED strip at the cutting line

#### 3. Camera

#### 4. Illumination

#### 5. Laser

- Projects clear information regarding processing and handling directly onto the current workpiece
- Arrows, for example, indicate the direction in which a panel needs to be turned and how it needs to be positioned. An X means that the wrong part has been inserted. The trash can symbol indicates waste parts
- In short: thanks to the self-explanatory symbols, operators always know which step they need to perform next and can immediately take the appropriate action

## Destacking concept: for zero errors – even with mixed stacks

The destacking concept guides the operator from depositing the first part to forming the perfect stacked pallet. This has been achieved by combining software and hardware in an overall concept. The software tells the machine operator when and where he should stack each particular part. You select the appropriate hardware according to your requirements. Altogether, this adds up to improved efficiency and ergonomics for all work steps. Times and routes that do not add value are systematically reduced.

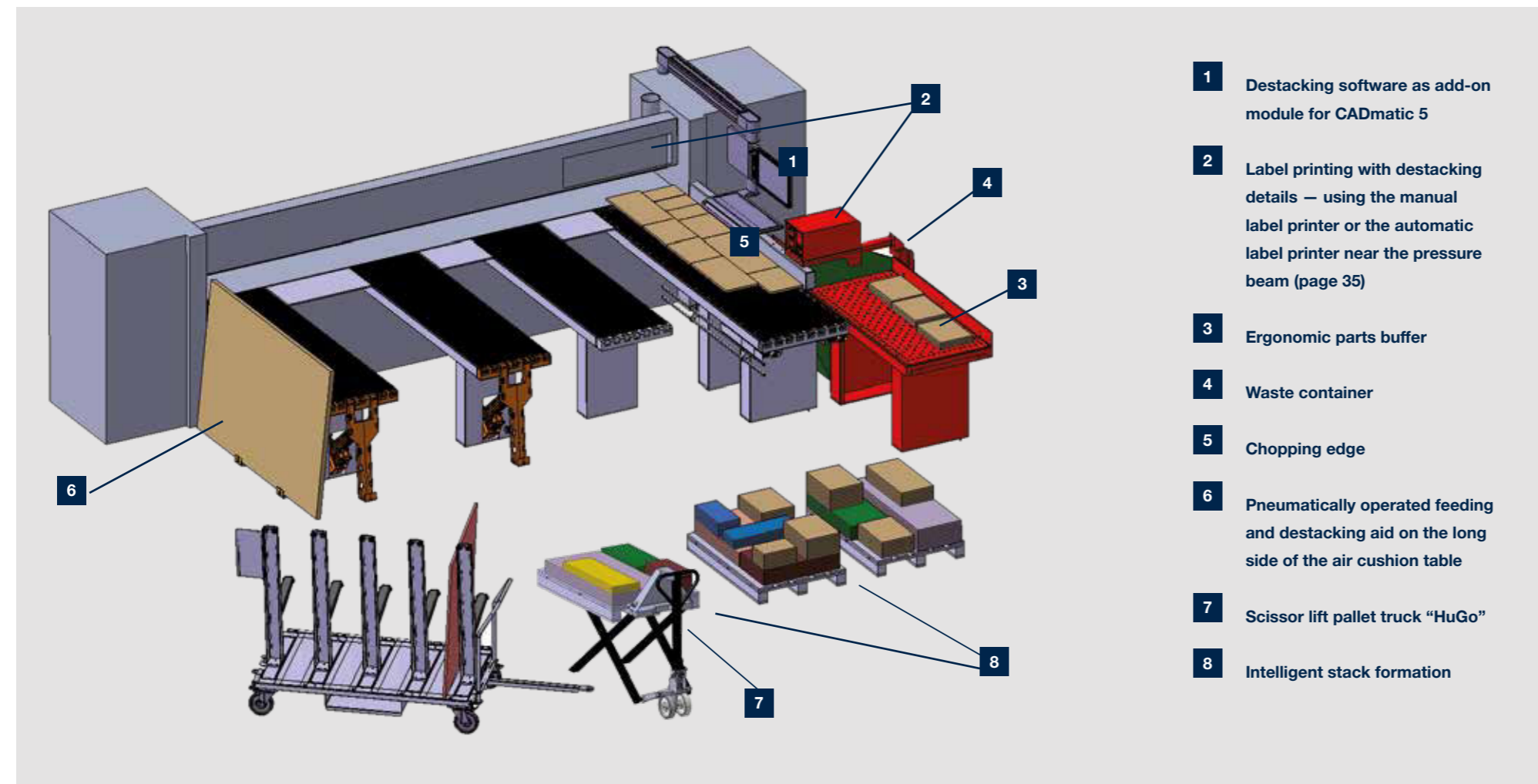

- 1 Destacking software as add-on module for CADmatic 5
- 2 Label printing with destacking details – using the manual label printer or the automatic label printer near the pressure beam (page 35)
- 3 Ergonomic parts buffer
- 4 Waste container
- 5 Chopping edge
- 6 Pneumatically operated feeding and destacking aid on the long side of the air cushion table
- 7 Scissor lift pallet truck “HuGo”
- 8 Intelligent stack formation

### MORE AT HOMAG.COM



Destacking concept

#### Benefits

- The operator is guided and always knows where he needs to stack each particular part
- Saves space, as demonstrably fewer pallets are required
- Intelligent stack formation according to individual specifications
- Reduces the walking required
- No more time wasted looking for the right destacking location
- Lowers the error rate considerably



#### CADmatic destacking module

Which part goes where? The CADmatic destacking module answers this question by means of an integrated destacking graphic. This option is available in the versions lite and practive. In both versions, the individual parts are color-coded in the cutting pattern and also in the assistance graphic. This means the operator can see on the monitor exactly when he must place a particular part on a particular pallet.

Additional advantages of the practive destacking module: not only does the operator see which part he needs to stack on which pallet, he also sees the exact position on the pallet where he is to place the part.

This ensures intelligent, stable stack formation. Furthermore, the practive destacking module allows the program sequence and the destacking strategy to be controlled more finely and appropriately. You can specify, for example, whether the stack formation is optimized for subsequent processing steps on the basis of the order or the material. These priorities can be combined with one another and weighted according to the primary objective.

This results in clear, highly efficient operator guidance with less walking between the saw and the destacking location, optimized pallet utilization and process-optimized, stable stack formation.



#### Scissor lift pallet truck “HuGo”

The scissor lift pallet truck “HuGo” is equipped with automatic height control and facilitates ergonomic and intelligent destacking processes. A light barrier controls the automatic raising and lowering of the pallet truck, also allowing you to remove all the parts from the pallet at an ideal working height – at an edge banding machine, for example.



### MORE AT HOMAG.COM



Pallet truck “HuGo”

#### Parts buffer with swiveling label printer

The parts buffer with swiveling label printer increases the efficiency of processes and optimizes handling.

- The parts buffer indicates to the operator by LED display whether a part should be temporarily stored. This is particularly useful for forming stable stacks or to avoid slowing down the saw, for example. The process of temporarily storing parts is itself very ergonomic.
- The swiveling label printer is located in a convenient position for the operator and dispenses the right label for each part at the right time.



Illustrations may show the technical principle but not the precise machine variant described. Further optional features, for example, may be shown.



## SAWTEQ B-500

This saw boasts innovative technologies and a uniquely rugged design.  
Saw blade projections of 150 mm or 170 mm ensure demand-based performance.

### The highlights

- Cutting length up to 6,500 mm
- Equipped with high-end technologies



## SAWTEQ B-500 with lifting table

This saw improves ergonomics by providing the option of automatic feeding via the robust lifting table. This feature speeds up the production process even further.

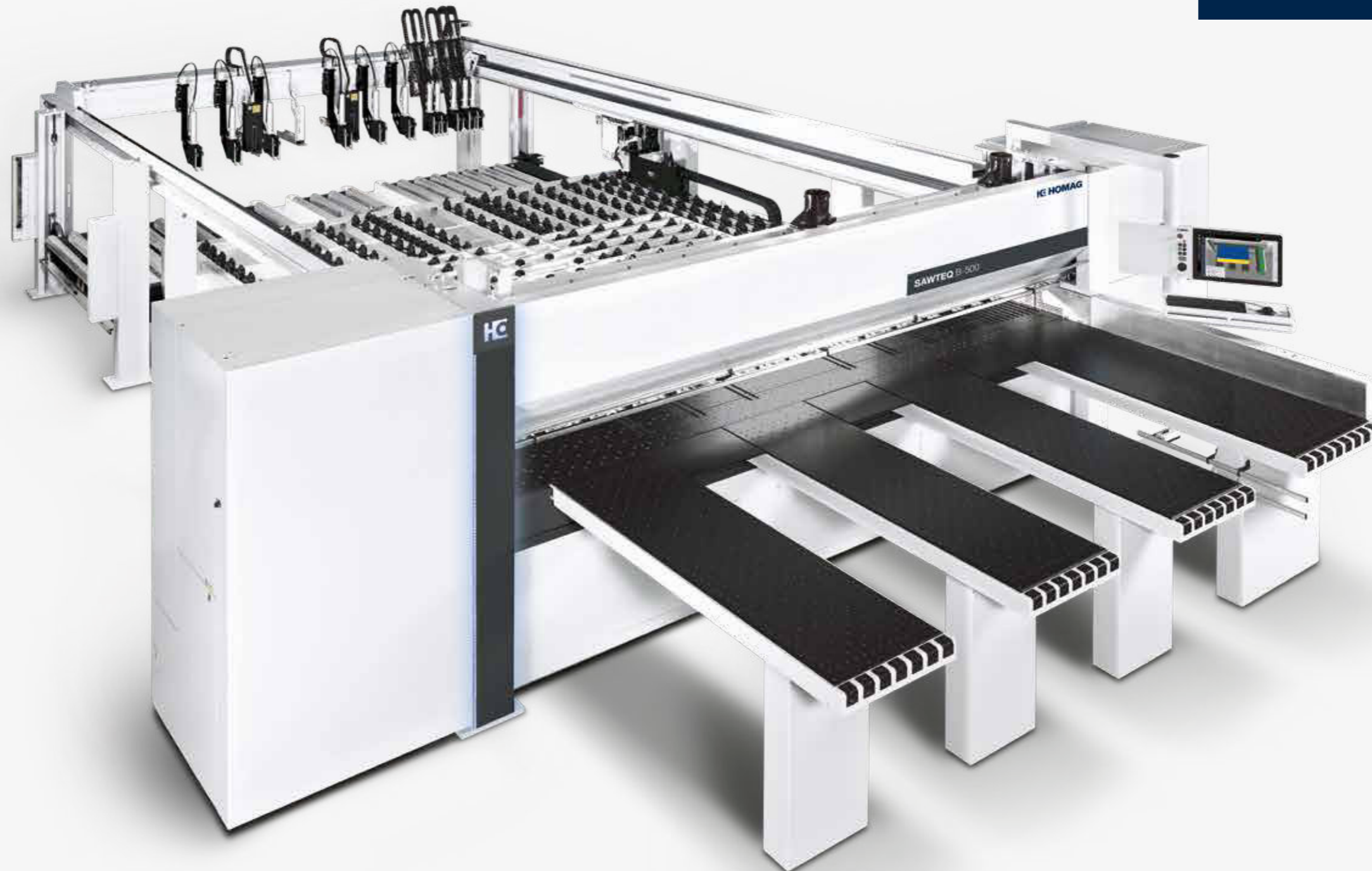

### The highlights

- Short production cycles due to automatic feeding
- Extremely rugged and designed for maximum operational demands
- Cutting length up to 6,500 mm

## SAWTEQ B-500 as angular saw unit

As an angular saw unit, the SAWTEQ B-500 has an impressive maximum output over a short period of time. Fully automated and particularly powerful, it will propel your production to new levels of performance.

### The highlights

- Angular saw unit for industrial use
- Maximum output due to fully automatic rip and cross cutting
- Cutting length up to 5,600 mm
- Suitable as a stand-alone solution or for integration in production lines



## Standard features

The standard versions of the SAWTEQ B-500 high-performance saws offer the full range of technical features and can be used flexibly, either as stand-alone machines or interlinked with other machines as part of a production line, depending on the production concept.

### **The highlights:**

- Heavy-duty saw body made of SORB TECH mineral compound
- Equipped with the latest CADmatic 5 control software
- Extremely energy efficient thanks to intelligent ecoPlus technologies
- Low maintenance, ergonomic and intuitive operation





## ecoPlus – because efficiency starts with the use of resources

Energy, time, material and personnel are all precious resources. Conserving them increases productivity and saves costs. The ecoPlus technologies from HOMAG help you to achieve this aim, providing countless innovations that save energy and reduce your operating costs. What's more, ecoPlus reduces CO<sub>2</sub> emissions and protects the environment. A worthwhile investment twice over.

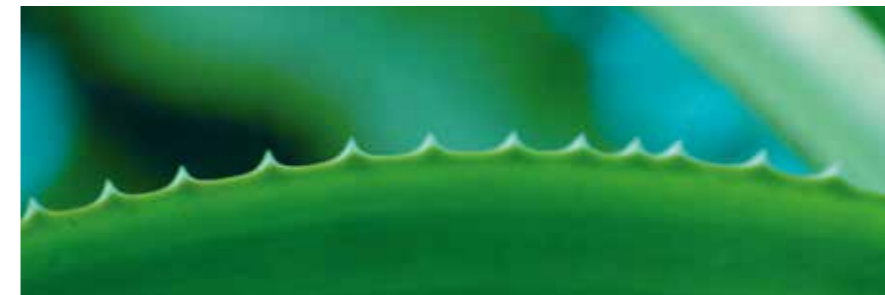

### ecoPlus technologies for maximum energy savings

- The standby button, a standard feature, puts the saw in an energy-saving standby mode at the touch of a button
- SAWTEQ B-500 with IE3 motors
- Variable speed control by means of a modern bypass circuit for all models with frequency-controlled main saw motor (optional)
- The geometry of the saw carriage enables highly efficient dust extraction
- Less energy required thanks to optimized dust extraction
- Thin-kerf saw blades can be used on request, ensuring less waste among other benefits
- Many innovations for improved ergonomics and smooth production processes

### WITH ECOPLUS, YOU SAVE:

up to **20%** of energy\*

\* Compared to our older saws

## High performance is the result of numerous high-tech solutions

Speed, quality and precision during the cutting process can only be achieved if panel materials are moved quickly, gently and with a high level of accuracy. For SAWTEQ B-500 saws, this is ensured by numerous technologies that interact smoothly with one another – from the program fence and pressure beam to the clamps and patented side pressure device.



### Program fence for precision and dimensional accuracy

- Resistant to torsion and bending
- Electronically controlled
- Precise linear guidance on H-girder
- Electromagnetic measuring system guarantees a positioning accuracy of +/- 0.1 mm/m, allowing for minimal trim and dust cuts
- No wear and no maintenance

### Pressure beam

- Rugged design
- Extremely short cycle times thanks to a dynamic pneumatics system
- Impressive dust extraction thanks to the special geometry in the pressure beam – dust is extracted without causing any turbulence and via the shortest route, even through the right-angled fence
- Micro-joint technology: slots for optional clamps are securely sealed, but can be opened easily if required
- Clip-in brushes (patented) attached to the inside of the clamp slots seal the pressure beam and prevent dust from escaping. The brushes can be changed quickly and easily thanks to clip system
- CADmatic automatically controls the contact pressure of the pressure beam for the specific workpiece – always over the entire cutting length, for minimum torsion
- Special pressure beam guidance to allow for durability and lasting precision



### Patented: central side pressure device

- Integrated directly in the saw carriage, which shortens cycle times by up to 25% in comparison with conventional systems
- Infinitely variable adjustment of contact pressure – depending on panel thickness. This allows even thin panels, laminates or sensitive materials to be processed perfectly. Another key feature here is the book-height-dependent control of the contact pressure: the higher the book, the greater the pressure

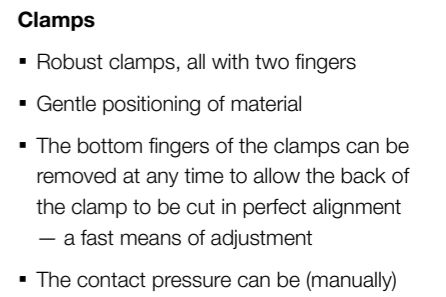
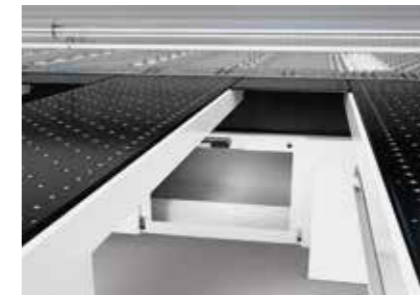

### Clamps

- Robust clamps, all with two fingers
- Gentle positioning of material
- The bottom fingers of the clamps can be removed at any time to allow the back of the clamp to be cut in perfect alignment – a fast means of adjustment
- The contact pressure can be (manually) adjusted individually and irrespective of the book height for the material being processed
- The top fingers of the clamps do not exert any leverage; instead, they are lowered horizontally and their entire contact surface rests on the material. This increases the working depth and ensures material is held firmly
- Program-activated clamps prevent damage to panel edges (optional)
- Designed for continuous, multi-shift operation

### Handy cleaning flap

Quick and convenient: the area under the saw carriage is easily accessible via flaps, allowing easy removal or vacuuming of cutting waste.

### MORE AT HOMAG.COM



Central side pressure device



Cleaning flaps

## The saw carriage: high performance, low consumption

Exceptionally smooth running, high precision and low energy consumption are the hallmarks of the saw carriage developed especially for the SAWTEQ B-500.



### Power-Loc system

Making it quick and easy to change the saw blade.

### MORE AT HOMAG.COM



Power-Loc

### Saw carriage

- Torsion-resistant, rugged and resilient basic design of the steel plate body for maximum dynamics and precision
- Infinitely variable feed speed – for precision cutting of demanding materials
- Long-term accuracy of saw blade projection
- Fast, precise and infinitely variable positioning of the main saw blade by means of linear guide system with rocker arm
- Motorized lift with electrically driven ball-screw spindle for raising the main saw blade (available as an option for even more speed)
- Equipped as standard with cutting line control: a sensor on the saw carriage monitors the cut and registers even minute deviations of the saw blade. If machine and quality specifications are not met, cutting immediately stops: the saw blade is lowered and moved back, and the cut is repeated – at an adjusted speed if necessary
- All main and scoring saw parameters can be stored. This means that the pair of saw blades can be refitted after sharpening without requiring readjustment (available as option if the scoring saw is motor lifted). The “camera-controlled scoring saw adjustment” option (page 48) makes this even easier
- Low-noise, maintenance-free main saw blade drive
- Spring-pressured running rollers (patented) ensure perfect contact with the guides even after several years of use
- Light sensor with blower unit
- Easy-to-maintain design for minimal belt wear and simplified belt changes
- Just a few central and easily accessible lubrication points
- Innovative dust extraction technologies

## Extremely stable and low levels of vibration thanks to SORB TECH

The SORB TECH saw body of the SAWTEQ B-500 is designed for maximum precision despite extreme loads. SORB TECH is a low-vibration and torsion-resistant material that is uniquely stable and available only for saws from HOMAG.



### Saw body made of SORB TECH

The faster a machine operates, the higher the susceptibility to vibrations and the noise level become. This is why the SAWTEQ B-500 saw body (machine base) is made of SORB TECH. This innovative construction material consists of hard stone grit in various sizes that is combined with bonding agents and special additives to form a casting compound specifically designed for the requirements.

The result: even after many millions of load changes, the saw body is extremely torsion resistant, stress free, quiet and stable, emitting only low levels of vibration.

- This enables the saw carriage and therefore the saw blades to run in an extremely precise manner
- Less wear and longer service lives – this reduces the operating costs
- Machine table at a comfortable working height
- SAWTEQ B-500 models are much quieter than other saws thanks to SORB TECH

### THE BENEFITS OF SORB TECH in comparison to designs with steel supports

**10 times** higher vibration damping

**20%** higher sound absorption

**30%** longer service life for saw blades

**40%** less primary energy needed for manufacturing processes

## More technology from the start – for saws with lifting table and angular saw units

Panel dividing saws with integrated lifting table and angular saw units set themselves apart with their automatic feeding system and increased level of automation. In short, these saws work differently from the standard SAWTEQ B-500 and therefore require additional technical solutions even in their standard version.



### Powerful feeding system

- Panels are fed via the electro-hydraulic four-column lifting table
- Automatic determination of book height
- Equipped as standard with longitudinal profiles and sensing device
- Suitable for thin materials from 9.5 mm upwards. Suitable for materials from 3 mm upwards if equipped with the optional micro-feed and hold-back device
- Maintenance-free and no lubrication required

### Transfer to cross cut saw (angular saw unit)

- Cross transfer via sub-surface carriage
- Energy-saving motorized aligners
- Rollers can be raised/lowered
- Alignment process with clamps, sub-surface carriage and right-angled fence
- Lengthwise aligning device before the cross cut saw that can be raised/lowered

### Separate backing wall

- Detached from the machine support to ensure precise cuts
- Feed-stacking, aligning and unloading books of panels has no effect on the machine bed



### Pull-out and waste flap at the rip saw (angular saw unit)

- 1** Waste flap with rollers for automatic waste removal at the rip saw
- 2** Rip saw pull-out ensures easy onward transport, even when processing narrow strips



## Optional features

More technology for customized production down to the very last detail: these features allow you to supplement the functionality of your saw in line with your requirements – from adding a link to a storage system and performing the actual cutting process to labeling and destacking. So you get exactly your solution.



## Feeding solutions ranging from S to XXL

Manually transporting materials from storage to the saw is extremely complex and time consuming. This process also requires a significant amount of space and is anything but gentle on materials. All the better then that tailored automation solutions are available from HOMAG for virtually all sizes of business – from simple loading solutions via the lifting table to a large-scale storage control connection.



### Large-scale storage connection

HOMAG offers a range of high-performance solutions for large businesses and customers with strict automation requirements. What's more, the SAWTEQ B-500 is open for connection to virtually all storage systems, ensuring the very highest level of performance.

Illustrations may show the technical principle but not the precise machine variant described. Further optional features, for example, may be shown.

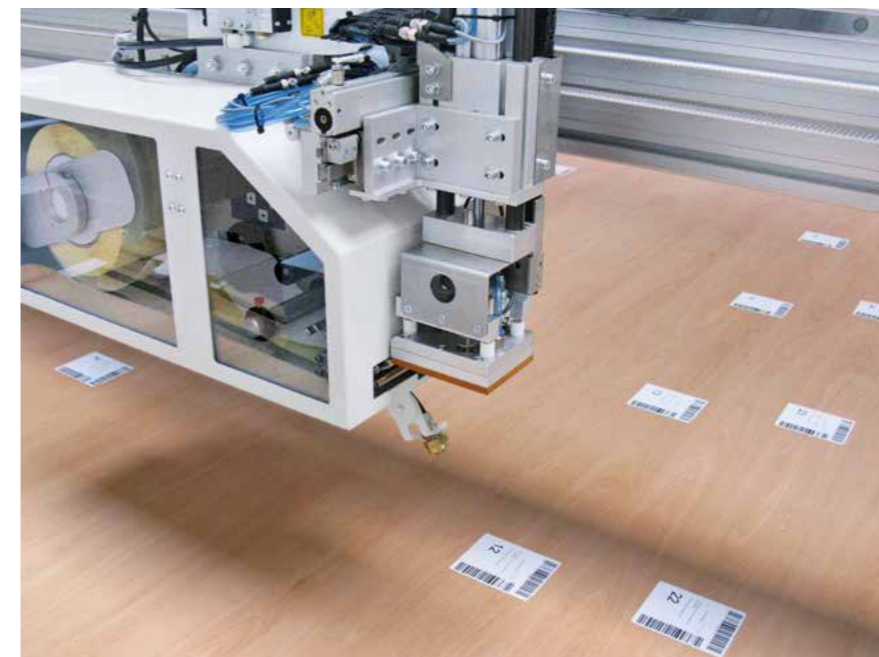

[MORE AT HOMAG.COM](https://www.homag.com)



Panel labeling system

### Panel labeling system

The innovation for saws with automatic storage integration: the HOMAG panel labeling system labels the panel before it is cut – independently of the saw, in non-productive time that previously went unused.

- Smallest part size 170 x 170 mm
- Up to 10 labels/min, optionally up to 15 labels/min
- Labeling independent of cutting process
- Saves time, because non-productive time is used productively
- Optimizes handling during destacking, because all the parts are already labeled
- Simplifies and speeds up production processes
- Automated parts tracking
- Can be retrofitted
- For smooth processes

## High-tech, even on the rear machine table

The rear machine table of the SAWTEQ B-500 can be customized with additional technologies that are as useful as they are high quality.

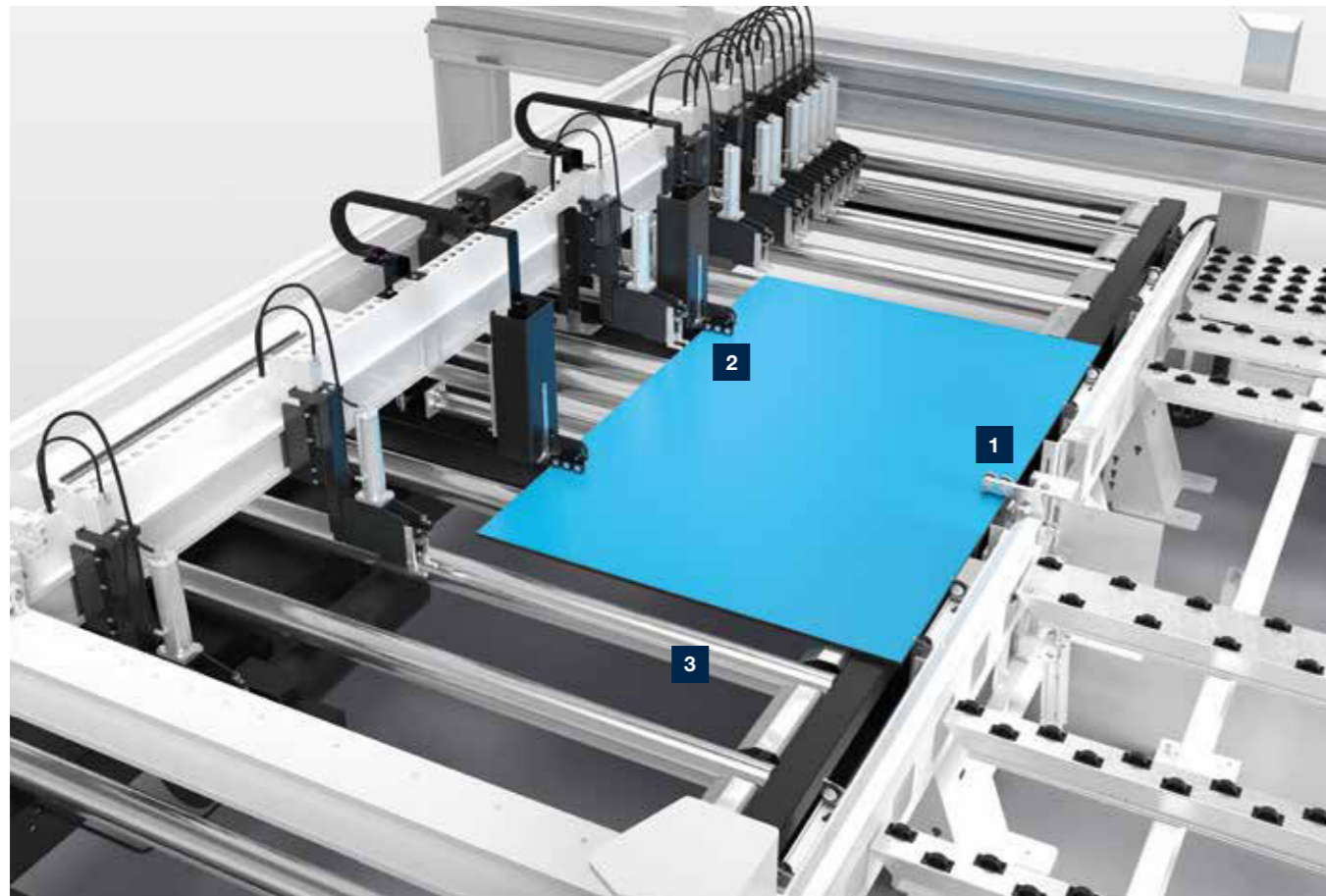

**1 Hold-back device for thin panels (for lifting-table saws and angular saw units only)**

For thin panels from a thickness of 3 mm.

**2 Micro-feed for thin panels (for lifting-table saws and angular saw units only)**

The micro-feed option allows thin panels from 6 mm upwards to be pushed onto the rear machine table (provided that their properties meet HOMAG specifications). Book height is measured by a non-contact, electromagnetic measuring system which is completely maintenance-free.

**3 Extra impetus for feeding (for lifting-table saws and angular saw units only)**

The automatically driven roller conveyor integrated in the lifting table and additional roller conveyors on the side ensure fast stack changeover.

**MORE AT HOMAG.COM**



Micro-feed



### Rotation device for headcuts

- Labor-saving device for operators
- With automatic aligning function
- Significant increase in output
- Process integrated perfectly in the machine cycle
- Less time required for preparation
- Easy operation

**MORE AT HOMAG.COM**



Rotation device



### Automatic ejecting device

- Pushes panel remnants from the rear machine table across the cutting line to the front
- You no longer need to reach into the cutting area
- Ergonomic

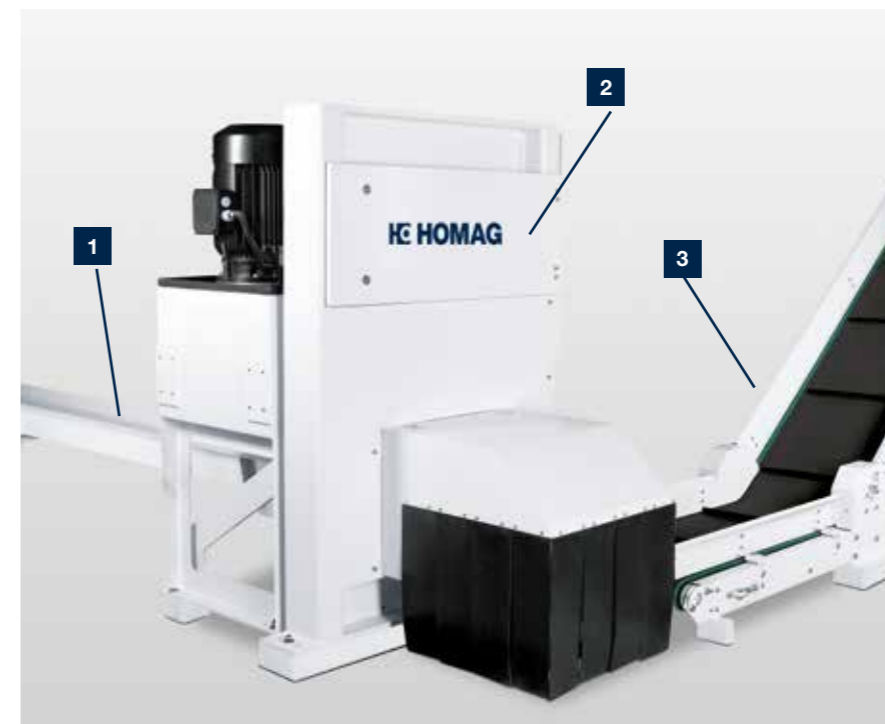

### Automatic waste removal (for angular saw units only)

- 1 Vibrating conveyor: cutting waste that falls through the waste flap collects here**
- 2 Waste chopper: cuts waste into small pieces, facilitating automatic removal of the cuttings**
- 3 Elevating conveyor belt for waste: transports cutting waste, for example, to a container**

## Power Concept speeds up production

At the heart of this technology is a clamp that can be moved separately. Using this clamp, several strips with different cross cuts can be cut to length together, significantly increasing material throughput.

### POWER CONCEPT

Up to **40%** more output



Lower costs per cut



Significantly improved material flow



High material throughput



### MORE AT HOMAG.COM



Power Concept professional

#### Power Concept professional works with:

- An additional clamp that operates independently
- Clamps on the program fence that can be raised out of the overlapping work area as needed
- Re-sorting the strips directly at the saw so that they are ideally matched to Power Concept professional. This is based on existing optimization data for the shortest machining times

The Power Concept professional clamp positions the last strip at the cutting line while the program fence fetches the next panel or book of panels from the lifting table. Furthermore, Power Concept makes it possible to process two strips of different lengths simultaneously. Good to know: to ensure your machine operators can master the considerably faster pace of production with ease, we recommend combining the system with the HOMAG destacking concept (page 14) or with intelliGuide (page 12).

#### Further benefits:

- Significantly shortened work cycles
- Attractively priced high-tech solution with minimum space requirement
- Precision cutting – even of very narrow strips

## Small detail, big impact

It is often the smallest details that make the difference. After all, when these details come together, they can have a noticeable impact on the speed and ease of the production process.



### Program-activated clamps

This option prevents damage to edges. Now also possible: automatic clamp activation in "measuring" mode.

### Extra-long cutting length

SAWTEQ B-500 saws are optionally available with a 5,600 mm or 6,500 mm cutting length.

### Additional clamps (not shown)

- For an even better grip on thin, narrow or smooth materials
- For increased material throughput

## MORE AT HOMAG.COM



Program-activated clamps



### Pneumatically operated trim stops

The trim stops are attached to the clamps and are activated as needed by the CADmatic machine control.

- Rugged
- Adjustable to common panel thicknesses
- Gentle handling of sensitive materials with overhanging laminates or veneers
- Precise positioning



### Dust-trap curtain on both sides

- Attached to the front and rear of the pressure beam
- Protects operators from dust
- Improves dust extraction
- Ideal for dust cuts



Pneumatically operated trim stops

## Solutions for special cutting tasks

Not only precise, but efficient. Under this banner, HOMAG offers you countless optional features for particular cutting tasks. Simply select your solution.

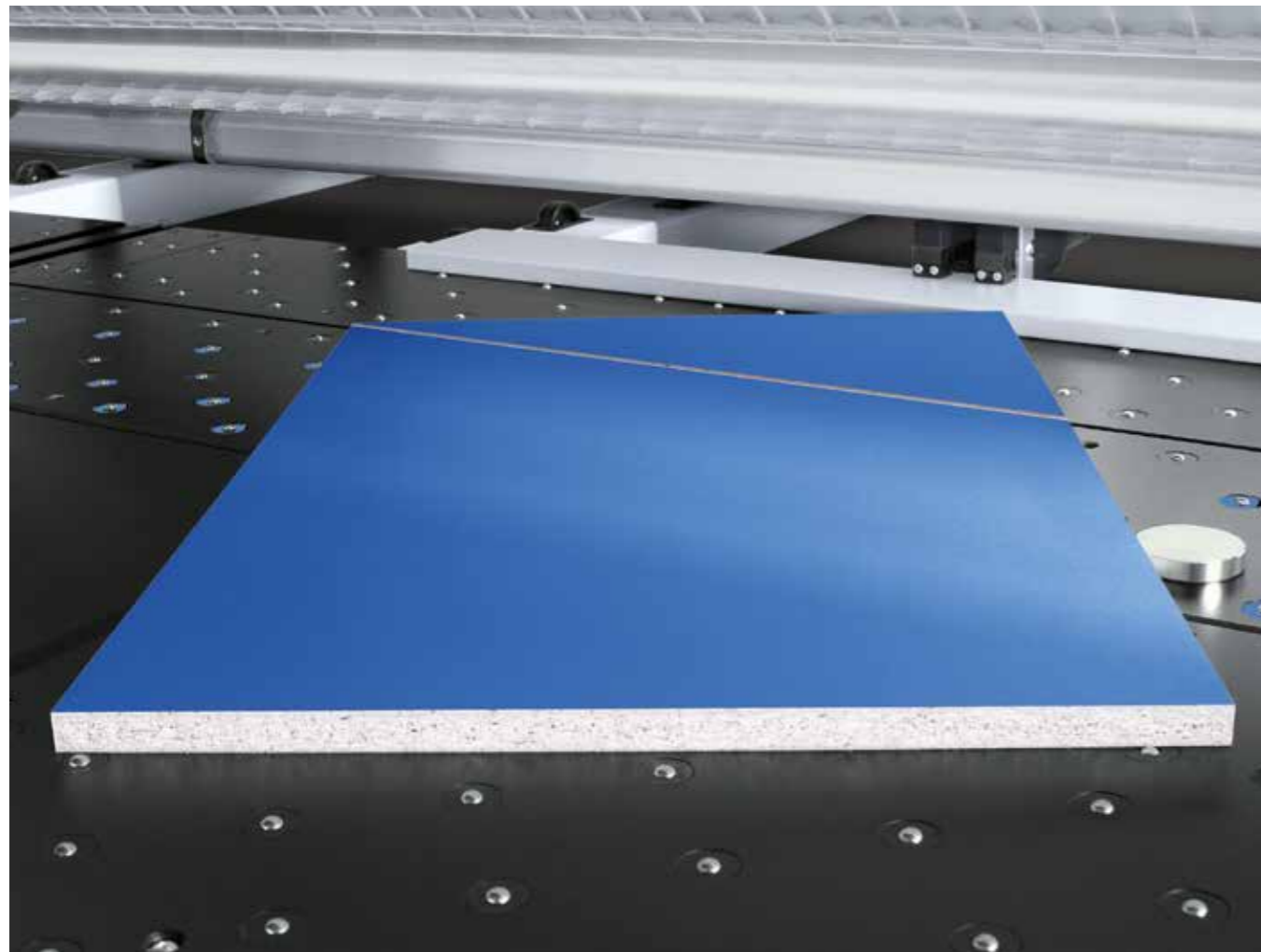

### Manual angle cut

The angle cut device allows you to control angle cuts using the CADmatic control software.

[MORE AT HOMAG.COM](#)



Manual angle cut

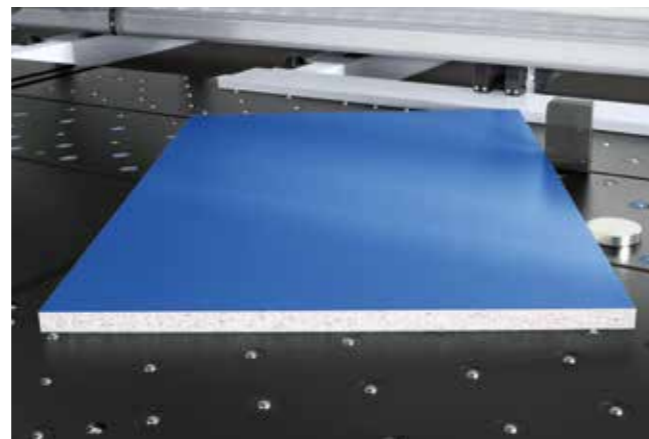

Illustrations may show the technical principle but not the precise machine variant described. Further optional features, for example, may be shown.



### Grooving and turbo grooving

These options save you an entire production step in subsequent processing. This is because your saw will also groove the panel material. The turbo-grooving option completes the grooves even much faster than a processing center.

[MORE AT HOMAG.COM](#)



Grooving

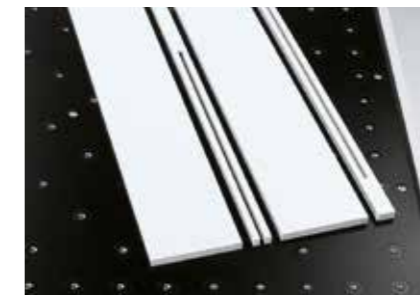

### Cut-out and stress elimination cut

Stress in the material is released when it is cut and can affect the quality of dimensions and cuts. The stress elimination cut option provides the solution. Systematic preliminary cuts can be defined during optimization and release the tension in the material. The additional cut-out feature allows you to produce both cut-outs and intermittent grooves in panels, as required for kitchen sinks or doors, for example.

[MORE AT HOMAG.COM](#)



Cut-out function



Stress elimination cut

## dustEx: making dust a thing of the past!

The more dust and chips that can be taken away by the dust extraction system, the better. After all, dust and chips can cause scratches on sensitive surfaces.



### Patented dustEx technology

dustEx guides dust and chips on a direct route towards the dust extraction system. How does it work? By means of combination air jets and optimized dust extraction geometry at the right-angled fence. To complete the dustEx package, we recommend using a dust-trap curtain on either side of the pressure beam (page 41).

### Air jets throughout the machine table (standard feature for angular saw units)

Anyone working with sensitive material or especially heavy panels and books will benefit from the machine table being equipped with air jets throughout.

### Light design (not shown)

Consists of the following options:

- LED illumination of the cutting line
- LED illumination of the saw blade change area
- LED illumination in the switch cabinet
- For simple, ergonomic working practices that protect the eyes

### MORE AT HOMAG.COM



dustEx

## The perfect postforming cut

The SAWTEQ B-500 takes care of this effortlessly and precisely with 55 mm saw blade projection.



### MORE AT HOMAG.COM



Postforming

### Postforming

- Vertical scoring saw raised by a motor (VRSS)
- Ensures perfect cuts on soft-formed and post-formed parts
- Maximum saw blade projection: 55 mm
- Includes automatic adjustment

## Air cushions for ergonomic operation

How can your machine operators handle heavy or excessively long parts with ease, even those that are susceptible to scratches? With innovative, tailored machine tables and air cushion tables from HOMAG of course! The choice is yours.



### MORE AT HOMAG.COM



Air cushion tables

#### Movable air cushion table

This air cushion table is easily moved along linear guides and offers you a mobile work surface and storage area. It allows you to move small panels, large panels or books of panels more ergonomically and with less risk of damage.

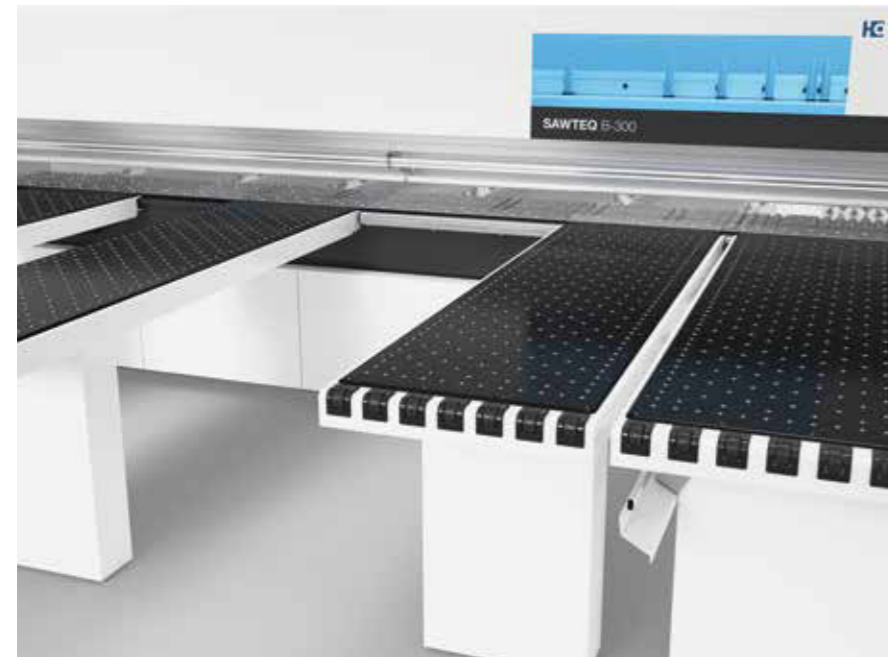

#### Extended air cushion tables (not shown)

- Extended from 2,160 mm to 2,810 mm
- Greater freedom of movement
- Better connection to destacking systems
- Very useful when cutting large-format panels

#### Wider table elements

Air cushion tables are optionally available in a width of 800 mm instead of 650 mm. Just one, two, three or all four – whatever is best for your production.



#### Tiltable air cushion table

- Prevents thin materials from sagging
- Increases the work surface
- Primarily for large panels and heavy books of panels
- Folds down for easy access to the cutting line



#### Additional start-stop button

- Allows the program sequence to be started independently of the control panel
- Equipped with an emergency stop button

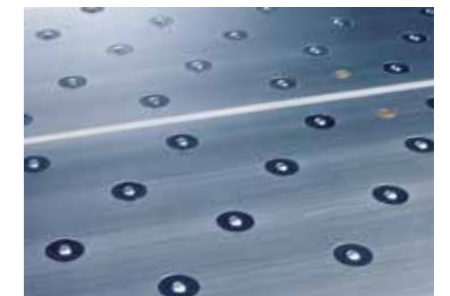

#### Anodized aluminum machine bed plates

The special coating ensures exceptionally gentle material handling. Ideal for materials with highly sensitive surfaces.



# Greater efficiency and control

Do you want to produce even more efficiently and monitor production processes with greater ease? You will find the right technology solutions for your cutting application here.



### Label printer

The label printer from HOMAG allows you to print customized labels directly at the saw and design them to include bar codes, text and graphics if required. If you also use our Cut Rite optimization software, the material goes directly to the next process step with printed instructions. In this way, you can integrate the saw perfectly in your production flow.

[MORE AT HOMAG.COM](http://www.homag.com)



Manual labeling

Illustrations may show the technical principle but not the precise machine variant described. Further optional features, for example, may be shown.

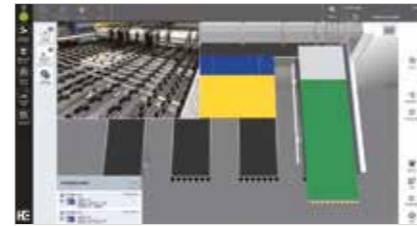

### Everything in view – with video monitoring

- Display of the camera image via the CADmatic control software
- You always have the rear machine table and feed system in view
- Camera pictures can be recorded if required for error diagnostics and workflow optimization purposes and sent to the HOMAG Service department



### Patented: camera-controlled scoring saw adjustment

This option allows the scoring saw to be adjusted fully automatically. Manual adjustment is still possible – controlled by the software via input on the touchscreen.

Its strengths:

- Optimum measuring results: the camera selects the color of lighting and the exposure time itself
- The simple adjustment takes no longer than a minute
- High-precision adjustment

TECHNICAL DATA*			
Model	B-500	B-500 with lifting table	B-500 as angular saw unit
Saw blade projection (mm)	150 (optional: 170)	150 (optional: 170)	150 (optional: 170)
Cutting length/width (mm)	3,200/3,800/4,300/5,600/6,500****	3,200/3,800/4,300/5,600/6,500****	Rip saw: 3,200/4,300/5,600 Cross cut saw: 2,200/2,700 2,200
Lifting table width (mm)	–	2,200	
Program fence speed (m/min)	90**	90**	Rip saw: up to 90 Cross-cut saw: up to 130**
Saw carriage speed (m/min)	up to 130 (optional: 150)	up to 130 (optional: 150)	up to 130 (optional: 150)
Main saw motor (kW)	50 Hz: 24 (optional: 47) 60 Hz: 28 (optional: 54)	50 Hz: 24 (optional: 47) 60 Hz: 28 (optional: 54)	50 Hz: 24 (optional: 47) 60 Hz: 28 (optional: 54)
Scoring saw motor (kW)	2.2	2.2	2.2
Average total air requirement (NI/min)	240	240	460
Required compressed air supply (bar)	6	6	6
Dust extraction system (m³/h)	6,000 (7,200****), 26 m/sec	6,000 (7,200****), 26 m/sec	13,100; 26 m/sec
Max. stack height without pit (mm)	–	660 (up to 4,300 cutting length) 550 (from 5,600 cutting length)	560 (up to 4,300 cutting length) 450 (up to 5,600 cutting length)
Max. stack weight (t)	–	4	4
Working height (mm)	1,020	1,020	920
Air cushion tables (mm)	3/3/4/5/6 x 2,160	3/3/4/5/6 x 2,160	2 x 2,160

\* Values relate to the standard version

\*\* Forwards 25 m/min

\*\*\* Dim. A: incl. 64 mm for dust extraction connection. Dim. C: standard program fence width. There are wider dimensions for the lifting table.

\*\*\*\* For the 5,600 mm cutting length

\*\*\*\*\* Only available in right-handed version

\*\*\*\*\* Maximum width that can be aligned

Technical data and photographs are not binding in every detail. We reserve the right to make changes in the course of further development.

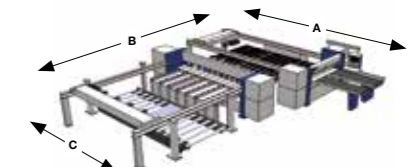
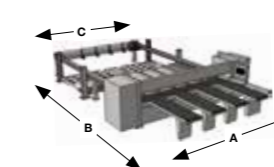
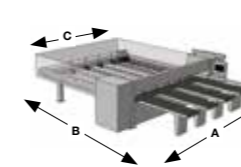

MACHINE DIMENSIONS***			
B-500 as single saw	A (mm)	B (mm)	C (mm)
B-500 32/32	6,235	6,693	3,660
B-500 38/32	6,795	6,693	4,220
B-500 38/38	6,795	7,293	4,220
B-500 43/32	7,385	6,693	4,810
B-500 43/38	7,385	7,293	4,810
B-500 43/43	7,385	7,843	4,810
B-500 56/56	8,735	9,843	6,160
B-500 65/65	9,735	10,908	7,160

MACHINE DIMENSIONS***			
B-500 as single saw with lifting table	A (mm)	B (mm)	C (mm)
B-500 32/16	6,235	9,318	3,660
B-500 38/22	6,235	10,078	3,660
B-500 38/16	6,795	9,318	4,220
B-500 38/22	6,795	10,078	4,220
B-500 43/22	7,358	10,078	4,810
B-500 56/22	8,735	11,418	6,160
B-500 65/22	9,735	12,308	7,160

MACHINE DIMENSIONS***			
B-500 as angular saw unit	A (mm)	B (mm)	C (mm)
B-500 32/22	9,170	13,850	3,636
B-500 43/22	10,320	13,850	4,786
B-500 56/22	11,670	13,850	6,136
B-500 56/27	11,670	16,190	6,136

# HC LIFE CYCLE SERVICES

Optimal service and individual consultations are included in the purchase of our machines. We support you with service innovations and products which are especially tailored to your requirements. With short response times and fast customer

solutions we guarantee consistently high availability and economical production – over the entire life cycle of your machine.



## REMOTE SERVICE

- Hotline support via remote diagnosis by our trained experts regarding control, mechanics and process technology. Thus, more than 90% less on-site service required and consequently a faster solution for you!
- The ServiceBoard App helps to solve tasks in a fast, simple and concrete way. This is achieved by mobile live video diagnosis, automatic sending of service requests or the online spare parts catalog eParts.



## SPARE PARTS SERVICE

- High spare parts availability and fast delivery.
- Ensuring quality by predefined spare parts and wear parts kits, comprising original spare parts.
- Identify and inquire for spare parts online under [www.eParts.de](http://www.eParts.de) 24/7, or buy even faster and more comfortably in the new HOMAG Webshop eCommerce.



## MODERNIZATION

- Keep your machinery up to date and increase your productivity as well as your product quality. This is how you can meet tomorrow's requirements today!
- We support you with upgrades, modernization as well as individual consultancy and developments.



## DIGITAL SERVICES

- ISN (intelliServiceNet) – The new remote service solution of the future! Fast restart of production because the remote service employee has extensive access to relevant physical data.
- intelliAdvice App – provides help for self-help. The preventive solutions proposed in the new App are the combination of our experiences and existing machine data.



## SOFTWARE

- Telephone support and consultancy through software support.
- Digitalization of your spare parts via 3D scanning saves time and money compared to new programming.
- Subsequent networking of your machinery with intelligent software solutions ranging from construction to production.



## FIELD SERVICE

- Increased machine availability and product quality by certified service staff.
- Regular checks through maintenance / inspection guarantee the highest quality of your products.
- We offer you the highest availability of technicians in order to reduce downtimes in case of unpredictable troubles.



## TRAINING

- Thanks to training perfectly suited to your requirements, your machine operators can optimally operate and maintain the HOMAG machines.
- Training also includes customer-specific training documents with exercises proven in practice.
- Online training and webinars. Learn without traveling, meet your trainer in the digital classroom.

For you more than...

**1,350**  
service employees worldwide

**90%**  
less on-site service thanks to  
successful remote diagnosis

**5,000**  
customer training sessions per year

**150,000**  
machines, all electronically documented  
in 28 different languages – in eParts

## **HOMAG Group AG**

info@homag.com  
www.homag.com



## **YOUR SOLUTION**